

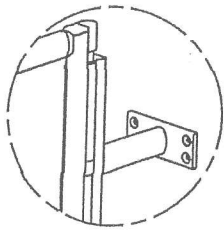



# Montageanleitung RFW/WA Installation Instructions RFW/WA



- 2 x 
- 2 x  6 x 33mm
- 8 x  5 x 60mm
- 8 x  8mm

**Achtung!**  
Schrauben und Dübel sind nur für den Einsatz in Vollbaustoffe und Hohlkammersteine geeignet!  
Bei anderen Wänden sind Spezialdübel zu verwenden!

**CAUTION!**  
Screws and anchors are suitable for use in solid construction materials and bricks/cinderblocks with hollow chambers!  
Use special anchors for all other types of walls!

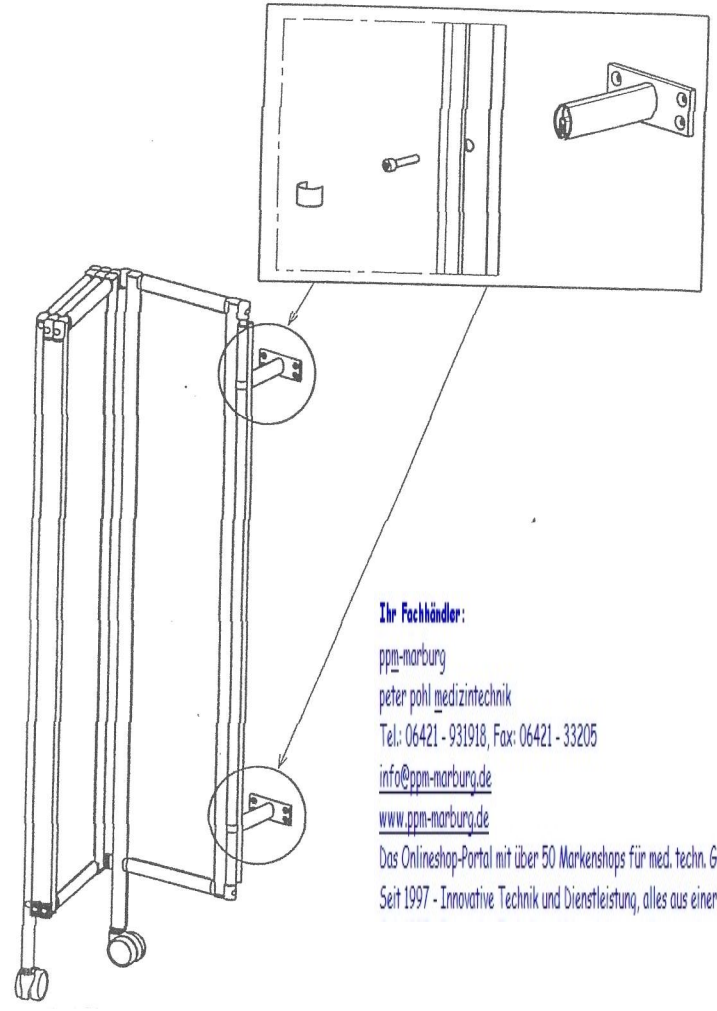
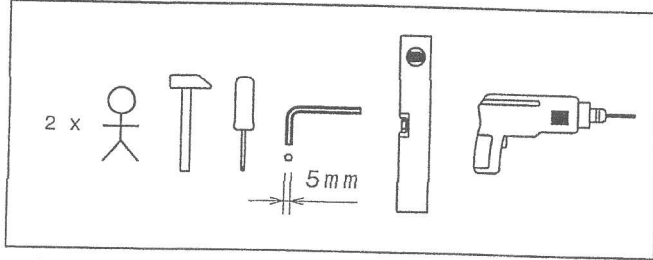

**Ihr Fachhändler:**  
ppm-marburg  
peter pohl medizintechnik  
Tel.: 06421 - 931918, Fax: 06421 - 33205  
[info@ppm-marburg.de](mailto:info@ppm-marburg.de)  
[www.ppm-marburg.de](http://www.ppm-marburg.de)  
Das Onlineshop-Portal mit über 50 Markenshops für med. techn. Geräte.  
Seit 1997 - Innovative Technik und Dienstleistung, alles aus einer Hand.

